



**Air velocity / airflow transmitter
CTV 210**



- Ranges from 0-1 m/s to 0-30 m/s (configurable) and 0-50 °C
- Interchangeable measurement probe
- Configurable intermediate ranges
- Airflow function
- Simultaneous display of 2 parameters
- 2 outputs 4-20 mA or 0-10V (4 wires), RS 232, 2 RCR relays 6A/230 Vac
- 2 visual (dual color LED) and audible (buzzer) alarms
- Output diagnostics
- ABS IP 65 housing, with or without 2-line backlit display
- Quick and easy mounting using the "1/4 turn" system with wall-mounting plate.

WITH or WITHOUT display



Transmitter features

Air velocity

Working principle : air velocity measurement is made using a hotwire in constant thermal equilibrium. The temperature is measured with a Pt 100 element.

- Measuring range0-1 m/s to 0-30 m/s
- Units of measurementm/s, fpm
- Accuracy *from 0 to 3 m/s : ±3% of reading ±0.03 m/s
from 3 to 30 m/s : ±3% of reading ±0.1 m/s
- Response timeT₆₃ = 1.6 sec.
- Resolutionfrom 0 to 3 m/s : 0,01m/s
from 3 to 30 m/s : 0,1 m/s
- Type of fluid.....air and neutral filtered gases

Temperature

- Measuring range.....0 to +50°C
- Units of measurement °C, °F
- Accuracy *±0,3% of the measurement ±0.25°C
- Response time t_{0,9} = 9 sec. for V_{air} = 1 m/s
- Resolution0.1°C
- Type of sensor.....Pt100 class A as per DIN IEC751
- Type of fluid.....air and neutral gases

Function

Class 200 transmitters have 2 analogue outputs which correspond to the 2 parameters displayed. You can activate 1 or 2 outputs and for each output, you can choose between air velocity, temperature and airflow.

Part number

To order, just add the codes to complete the part number :

Power supply / Output

- B** 24 Vac/Vdc • 0-10V or 4-20 mA
- M** 115 Vac • 0-10 or 4-20 mA
- H** 230 Vac • 0-10 or 4-20 mA

Display

- O** With display
- N** Without display

Probe length

- 150** mm
- 300** mm

CTV 210 - [] [] []

Example : CTV210-MN150 = air velocity and airflow transmitter type CTV 210, with 115 Vac power supply, without display, with hotwire probe length 150mm.

Features Functions	Measuring range	Units and resolutions
Airflow	0 to 100 000 m ³ /h <i>(depends on air velocity and duct dimensions)</i>	1 m ³ /h - 0.1 m ³ /s 0.1 l/s - 1 cfm

Housing dimensions

(including wall-mounting plate)

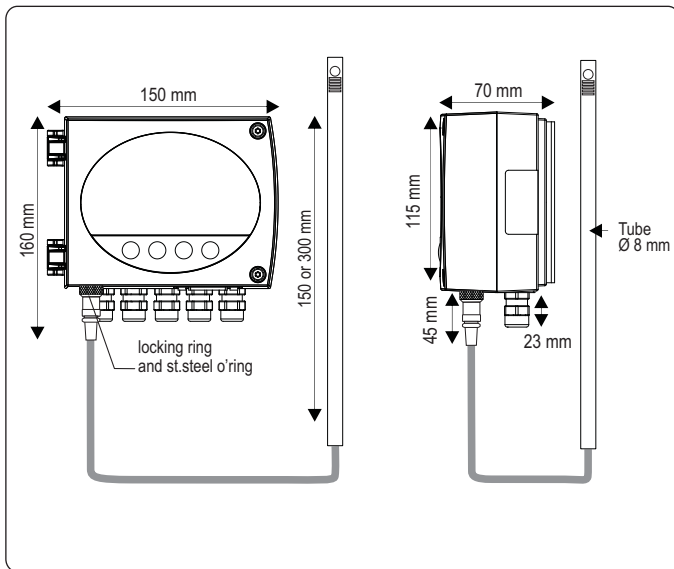

Relays and Alarms

Class 200 transmitters have 4 stand-alone and configurable alarms : 2 visual alarms (dual color LED) and 2 relays (contacts).

You can set :

- the parameter (air velocity, airflow, temperature)
- 1 or 2 set points (high and low) for each alarm
- the time-delay / 60 sec. max.
- the alarm action : rising or falling
- the relay operation mode : positive or negative security
- the audible alarm (buzzer) activation.

RS 232 communication

- Via the RS 232 connection, the CTV 210 can transmit its measurements to a KIMO Class 300 transmitter.

Example : a CP 300 can display (in addition to the pressure) other parameters such as air velocity and airflow from a CTV 210.

- Via the RS 232 communication, you can also configure your transmitter with the LCC-300 software.

- The RS 232 connection cable is available in lengths 2 m, 5 m or 10 m (maximum) lengths.



Hotwire probe features

Probe material	316 L stainless steel
Dimensions	Ø 8 mm, lg. 150mm or 300 mm
Working temperature	from 0 to +50°C
Cable	PVC Ø 4,8 mm, lg. 2 m

Housing features

Housing	ABS
Fire-proof classification	V.0 as per UL 94
Dimensions	see drawing alongside
Protection	IP 65
Display	alphanumeric, 2 lines of 16 digits, 98mm x 22mm, backlight protection screen made of PMMA
Connection fittings	polyamide for cables Ø 7 mm max.
Weight	800 g (with display)

Technical Specifications

Power supply	24 Vac / Vdc ±10%
	115 Vac or 230 Vac ±10%, 50-60 Hz
Output	2 x 4-20 mA or 2 x 0-10 V (4 wires)
	maximum load : 500 Ohms (4-20 mA)
	minimum load : 1 K Ohms (0-10 V)
Galvanic isolation	inputs and outputs (115 Vac/230 Vac models)
	outputs (24 Vac/Vdc models)
Consumption	5 VA
Relays	2 RCR relays 6A / 230 Vac
Visual alarms	2 dual color LED
Audible alarm	buzzer
Electro-magnetical compatibility	EN 61 326
Electrical connection	screw terminal block for cable Ø 1.5 mm² max
RS 232 communication	digital : ASCII, proprietary protocol
Working temperature	0 to +50°C
Storage temperature	-10 to +70°C
Environment	air and neutral gases

Configuration

You can configure all the parameters of the transmitter : **units, measuring ranges, alarms, outputs, channels, calculation formula...** via the different methods shown below :

- ☛ **Via keypad** : only on models with display.
A code-locking system combined with keypad guarantees the security of the installation. See configuration manual.
- ☛ **Via software** (optional) : on all models.
Simple user-friendly configuration. See LCC-300 user manual.

Configure the range according to your needs: outputs are automatically adjusted to the new measuring ranges.

Configurable analogue outputs

You can configure your own intermediate ranges from 0-1 m/s to 0-30 m/s and equivalent units.

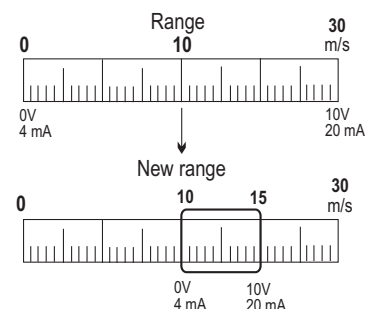

Connection

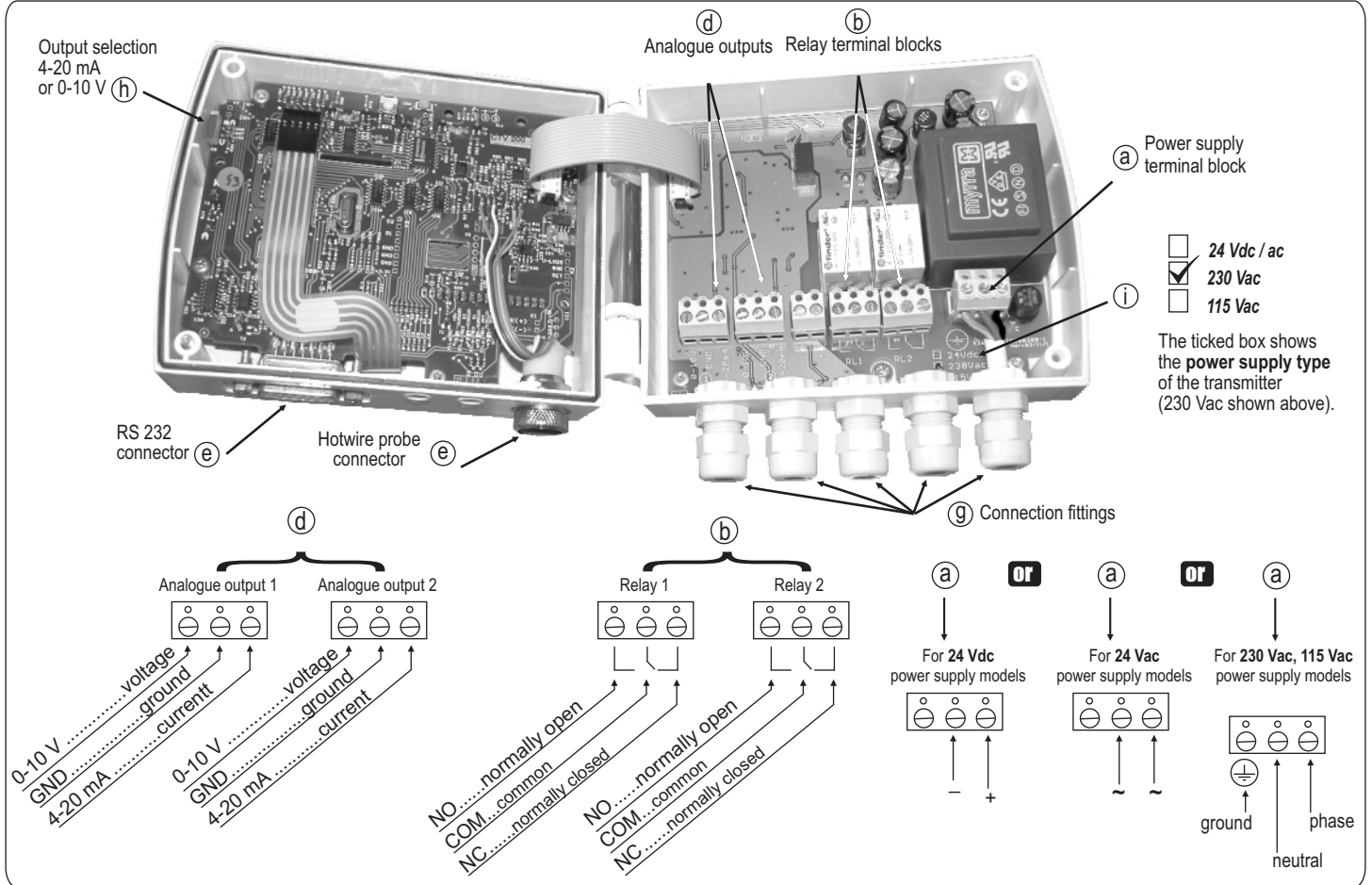

Electrical connections - as per NFC15-100 norm

⚠ This connection must be made by a qualified technician. Whilst making the connection, the transmitter must not be energized.

Power supply connection :

⚠ Before making the connection, you must first check the power supply which is indicated on the transmitter board see (i) on the connection drawing.

• For 24 Vdc power supply models :

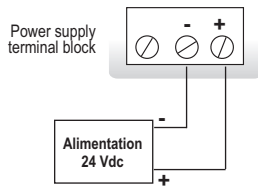

• For 24 Vac power supply models :

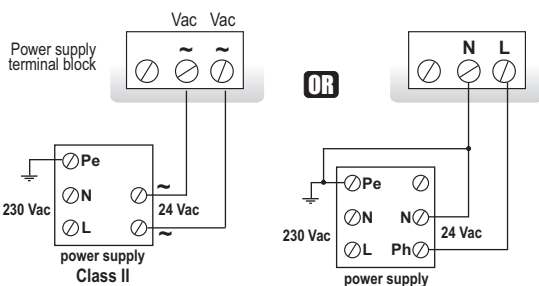

• For 115 or 230 Vac power supply models :

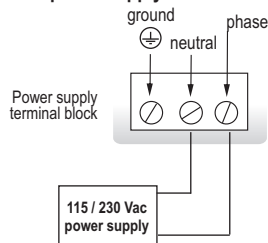

Output signal selection voltage (0-10 V) or current (4-20 mA)

The on-off switch located on the left top of the transmitter (see (h) on connection drawing) allows selection of the required outputs.

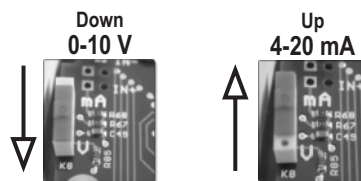

Output connection :

• 4-20 mA current output :

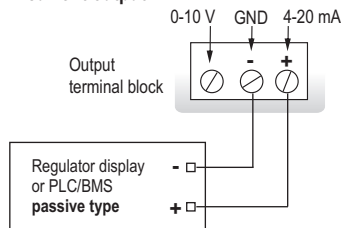

• 0-10 V voltage output :

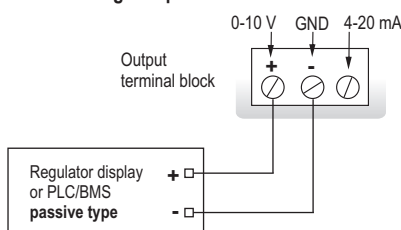

Connection of SUB-D15 RS232 (see (e) connection drawing)

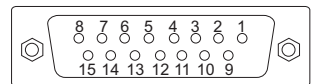

Pin #	Description
1	NC *
2	NC *
3	NC *
4	B -
5	A +
6	NC *
7	NC *
8	NC *
9	RX (RS 232)
10	NC *
11	TX (RS 232)
12	NC *
13	NC *
14	NC *
15	GND (RS 232)

⚠ CAUTION :
NC * --> DO NOT CONNECT

Calibration

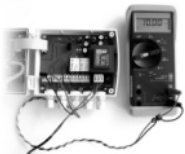

Output diagnostics :

With this function, you can check with a multimeter (or a regulator display, or a PLC/BMS) if the transmitter outputs work properly. The transmitter generates a voltage of 0 V, 5 V and 10 V or a current of 4 mA, 12 mA and 20 mA.

Certificate :

- Class 200 transmitters are supplied with adjusting certificates. Calibration certificates are offered as an option.

Maintenance

Avoid aggressive solvents.

Protect the transmitter and probes from any cleaning product containing formol, which may be used for cleaning rooms or ducts.

Options

- Configuration software type LCC 300 supplied with RS 232 connection cable
- Calibration certificate.



Optional accessories

- Sliding fittings
- Mounting brackets
- Cleaning spray for hotwire probe



Mounting

To install the transmitter on a wall : fix the stainless steel plate to the wall (this plate is supplied with the transmitter).

Drill 8mm holes and mount the plate with the screws and wall-plugs supplied with the transmitter. Insert the transmitter on the plate (see A on the drawing shown below), by aligning it at 30°. Rotate its housing in clockwise direction until you hear a "click" which confirms that the transmitter is correctly installed. Then, open the housing, lock the clamping system of the housing on the plate, with the screws as shown (to remove the transmitter from the plate, remember to remove the screws first).

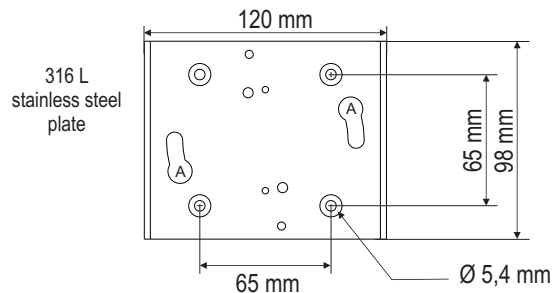
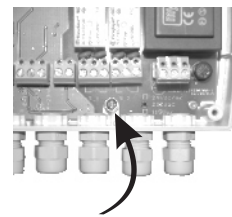

⚠ Positioning the measuring element in the air flow

Carefully slide back the sensitive element protection sheath. Position the probe perpendicular to the air flow => the red dot (located on the bottom of the probe) must face the air flow.

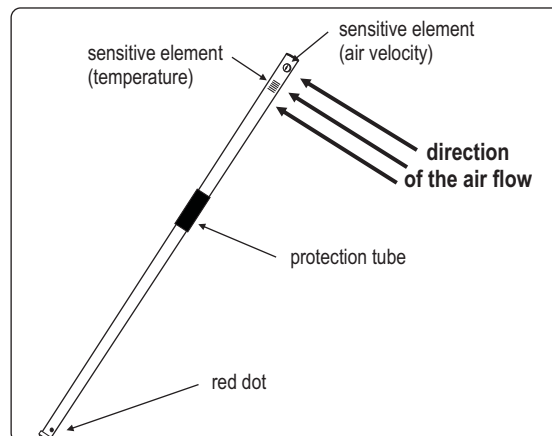

www.kimo.fr



EXPORT DEPARTMENT

Tel : + 33. 1. 60. 06. 69. 25 - Fax : + 33. 1. 60. 06. 69. 29

e-mail : export@kimo.fr

Distributed by :

RoMiotto **RoMiotto Instrumentos de Medição Ltda**
 Instrumentos de Medição
 Rua São Leonardo, 187 - Freguesia do Ó - São Paulo - SP
 Cep: 02803-000 | Fone.: (11) 3976-4003 - Fone.: (11) 3999-7737
www.romiotto.com.br | E-mail: info@romiotto.com.br